

Article number: 12621000200000

Description: Industrial tool 621 000 200.000
For M20

Measures

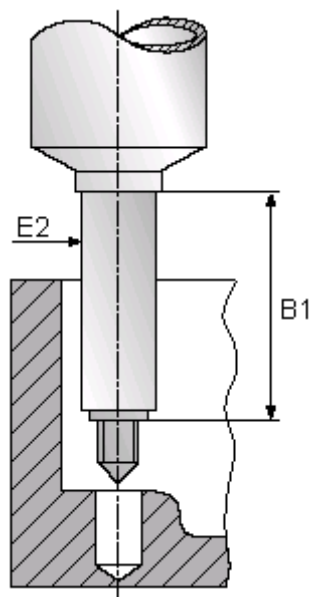

B1	= 60
E2	= 26
For thread	= M20